

MTP-LC Conversion Cassettes

MTP-LC conversion module is a high-density cassette, ideal for plug-and-play systems. The module consists of 12 LC fiber provides the optical circuit to interconnect the front and rear adapters.

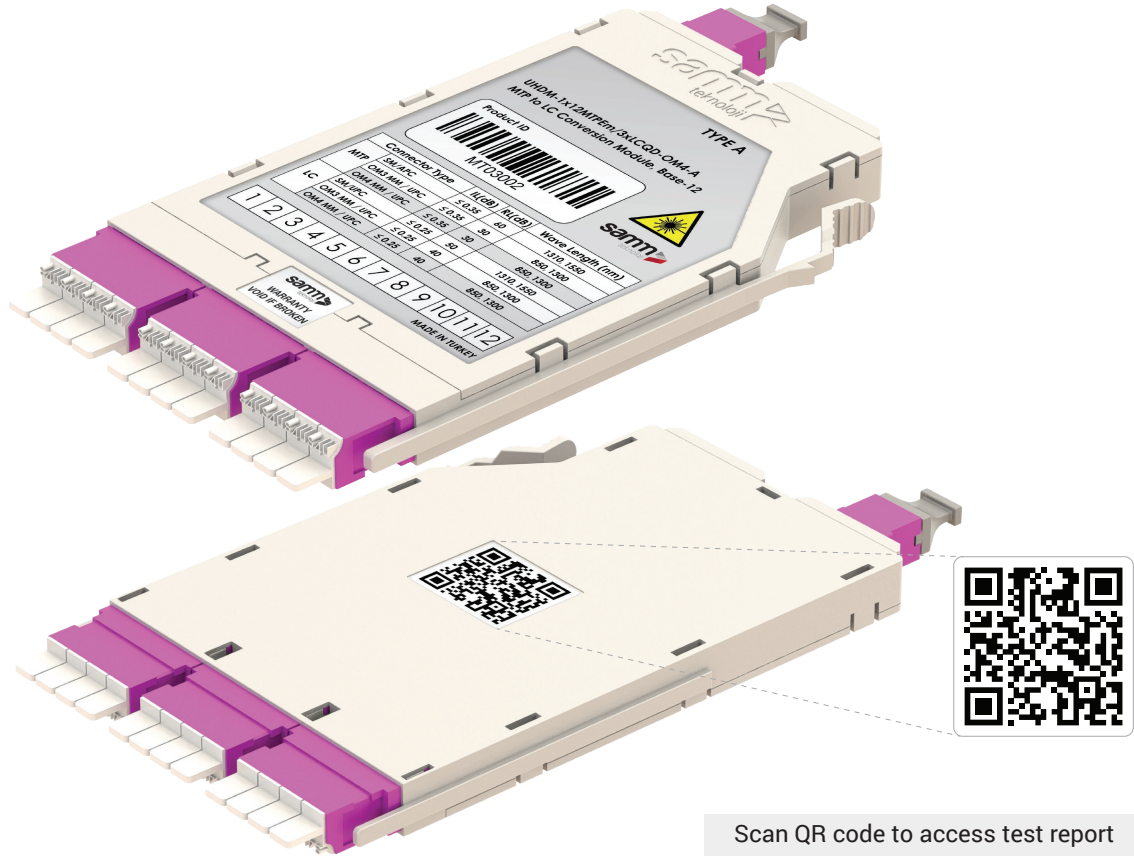

Applications

- Entrance facility
- Data center
- Telecommunications room
- Cellular tower base station
- Consolidation point
- Central office
- Equipment room

Key Features and Benefits

- Front and rear installation options on panel rail guides
- Sliding mechanism allows modules to snap into position for quick and easy, tool-less mounting
- High-density: up to 144 fibers in a 1U rack space
- Safety lock design against movement when installed
- Port numbering on the label
- Robust and Strong design
- Complete optical testing

Technical Specifications

Plastic cassette materials	PC/ABS Resin, Black
Flammability rate	UL94-V0
RoHS	Compliant
Operating temperature	-20°to +60°C
Storage temperature	-25°to +70°C

MTP-LC Conversion Cassettes Base-12

(Please choose the right polarity wiring and fiber type)

UHDM-1x12MTPEm/3xLCQD-OS2-A

OS2 MTP to LC Conversion Module , Base-12, Front 3x LC Quad Adapter Blue, Rear 1x MTP12, Pinned, Adapter Body Yellow, Allocation Type A

UHDM-1x12MTPEm/3xLCQD-OS2-AF

OS2 MTP to LC Conversion Module , Base-12, Front 3x LC Quad Adapter Blue, Rear 1x MTP12, Pinned, Adapter Body Yellow, Allocation Type AF

UHDM-1x12MTPEm/3xLCQD-OS2-B

OS2 MTP to LC Conversion Module , Base-12, Front 3x LC Quad Adapter Blue, Rear 1x MTP12, Pinned, Adapter Body Yellow, Allocation Type B

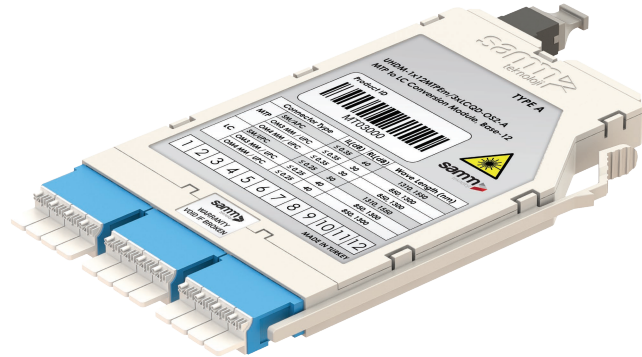

UHDM-1x12MTPEm/3xLCQD-OM3-A

OM3 MTP to LC Conversion Module , Base-12, Front 3x LC Quad Adapter Aqua, Rear 1x MTP12, Pinned, Adapter Body Black, Allocation Type A

UHDM-1x12MTPEm/3xLCQD-OM3-AF

OM3 MTP to LC Conversion Module , Base-12, Front 3x LC Quad Adapter Aqua, Rear 1x MTP12, Pinned, Adapter Body Black, Allocation Type AF

UHDM-1x12MTPEm/3xLCQD-OM3-B

OM3 MTP to LC Conversion Module , Base-12, Front 3x LC Quad Adapter Aqua, Rear 1x MTP12, Pinned, Adapter Body Black, Allocation Type AB

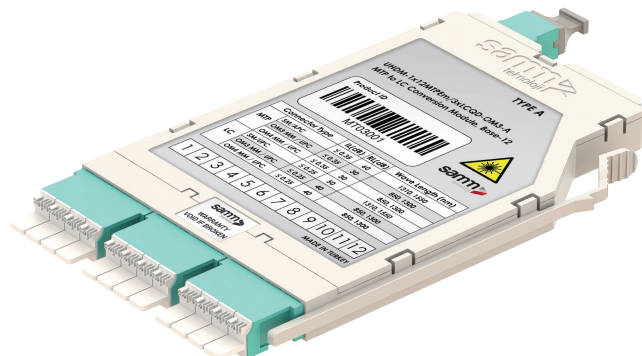

UHDM-1x12MTPEm/3xLCQD-OM4-A

OM4 MTP to LC Conversion Module , Base-12, Front 3x LC Quad Adapter Violet Rear 1x MTP12, Pinned, Adapter Body Black, Allocation Type A

UHDM-1x12MTPEm/3xLCQD-OM4-AF

OM4 MTP to LC Conversion Module , Base-12, Front 3x LC Quad Adapter Violet Rear 1x MTP12, Pinned, Adapter Body Black, Allocation Type AF

UHDM-1x12MTPEm/3xLCQD-OM4-B

OM4 MTP to LC Conversion Module , Base-12, Front 3x LC Quad Adapter Violet Rear 1x MTP12, Pinned, Adapter Body Black, Allocation Type B

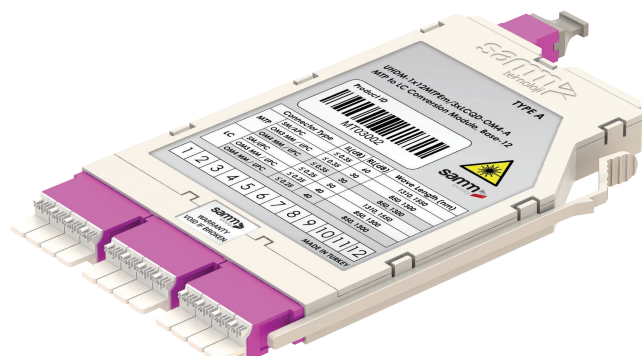

MTP-LC Conversion Cassettes Base-8

(Please choose the right polarity wiring and fiber type)

UHDM-1x8MTPEm/2xLCQD-OS2-A

OS2 MTP to LC Conversion Module , Base-8, Front 2x LC Quad Adapter Blue, Rear 1x MTP8, Pinned, Adapter Body Yellow, Allocation Type A

UHDM-1x8MTPEm/3xLCQD-OS2-AF

OS2 MTP to LC Conversion Module , Base-8, Front 2x LC Quad Adapter Blue, Rear 1x MTP8, Pinned, Adapter Body Yellow, Allocation Type AF

UHDM-1x8MTPEm/3xLCQD-OS2-B

OS2 MTP to LC Conversion Module , Base-8, Front 2x LC Quad Adapter Blue, Rear 1x MTP8, Pinned, Adapter Body Yellow, Allocation Type B

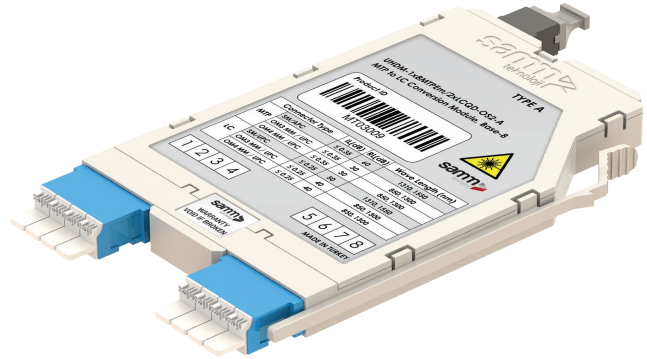

UHDM-1x8MTPEm/2xLCQD-OM3-A

OM3 MTP to LC Conversion Module , Base-8, Front 2x LC Quad Adapter Aqua, Rear 1x MTP8, Pinned, Adapter Body Black, Allocation Type A

UHDM-1x8MTPEm/2xLCQD-OM3-AF

OM3 MTP to LC Conversion Module , Base-8, Front 2x LC Quad Adapter Aqua, Rear 1x MTP8, Pinned, Adapter Body Black, Allocation Type AF

UHDM-1x8MTPEm/2xLCQD-OM3-B

OM3 MTP to LC Conversion Module , Base-8, Front 2x LC Quad Adapter Aqua, Rear 1x MTP8, Pinned, Adapter Body Black, Allocation Type AB

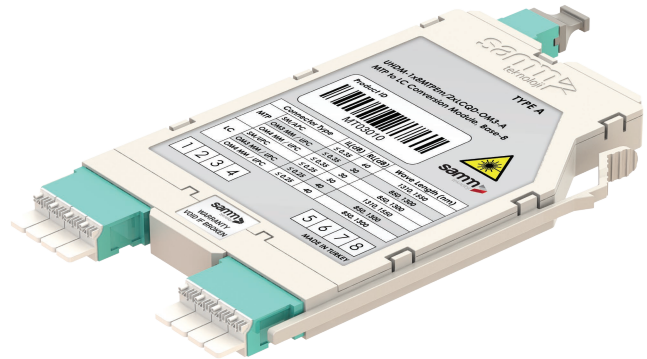

UHDM-1x8MTPEm/3xLCQD-OM4-A

OM4 MTP to LC Conversion Module , Base-8, Front 2x LC Quad Adapter Violet Rear 1x MTP8, Pinned, Adapter Body Black, Allocation Type A

UHDM-1x8MTPEm/3xLCQD-OM4-AF

OM4 MTP to LC Conversion Module , Base-8, Front 2x LC Quad Adapter Violet Rear 1x MTP8, Pinned, Adapter Body Black, Allocation Type AF

UHDM-1x8MTPEm/3xLCQD-OM4-B

OM4 MTP to LC Conversion Module , Base-8, Front 2x LC Quad Adapter Violet Rear 1x MTP8, Pinned, Adapter Body Black, Allocation Type B

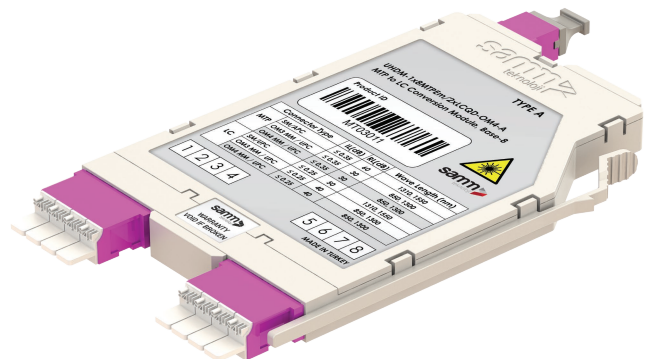

Optical Values

Connector Type		IL(dB)	RL(dB)	Wave Length (nm)
MTP	SM/APC	≤ 0.35	60	1310, 1550
	OM3 MM / UPC	≤ 0.35	30	850, 1300
	OM4 MM / UPC	≤ 0.35	30	850, 1300
LC	SM/APC	≤ 0.25	60	1310, 1550
	OM3 MM / UPC	≤ 0.25	40	850, 1300
	OM4 MM / UPC	≤ 0.25	40	850, 1300

Certification And Compliance

ANSI/TIA-942-A Telecommunications Infrastructure Standard for Data Centers	IEC 60874-1 Connectors for Optical Fibers and Cables; Generic Standard
ANSI/TIA-568-C.3 Optical Fiber Cabling Components Standard	IEC 61300 Fiber Optic Interconnecting Devices and Passive Components; Basic Test and Measurement Procedures
TIA-604 series Fiber Optic Connector Intermateability Standard	IEC 60874-1 Connectors for Optical Fibers and Cables ; Generic Standard
TIA-455 series Standard Test Procedure for Fiber Optic Components	UL 94 Tests for Flammability of Plastic Material for Parts in Devices and Appliances
GR-326-CORE Generic Requirements for Single Mode Optical Connectors and Jumper Assemblies	RoHS Directive on Restriction of Hazardous Substances

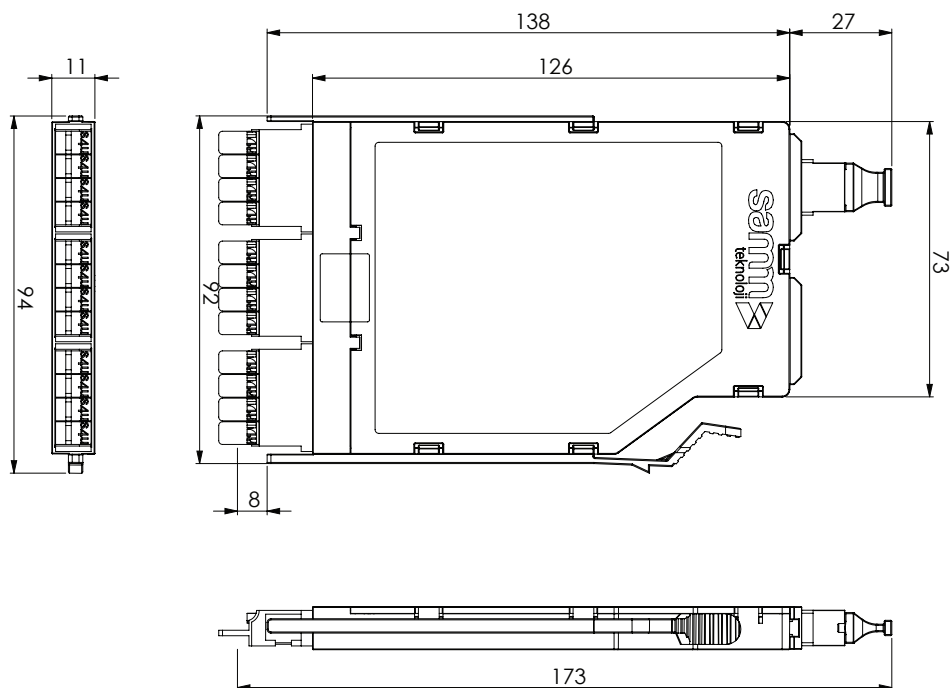

Wiring Design For Duplex Signals (Polarization)

Polarization Type A

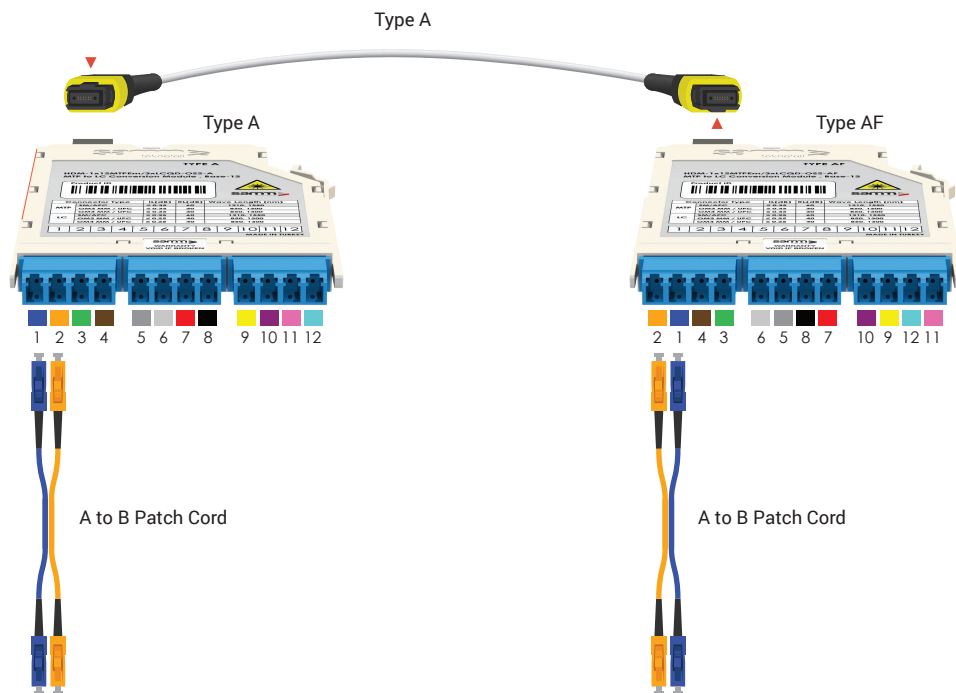
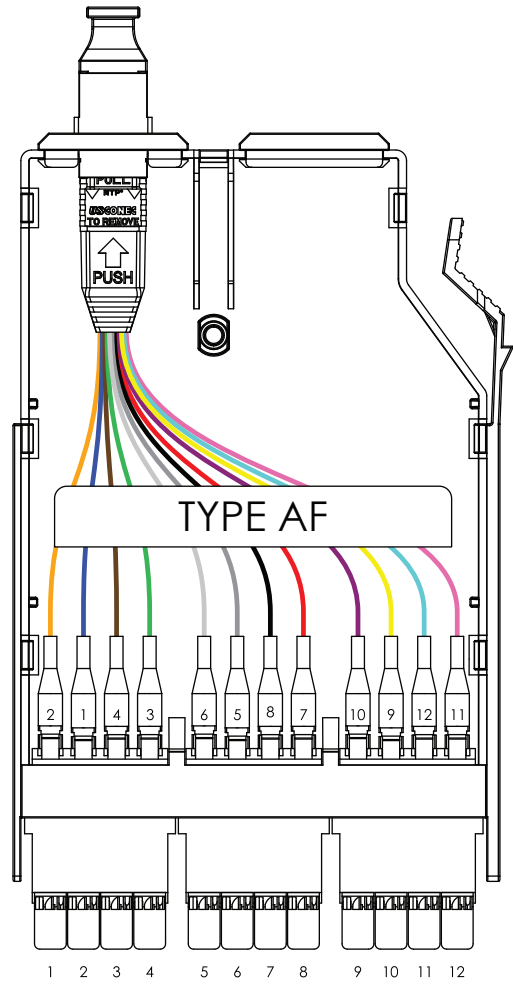
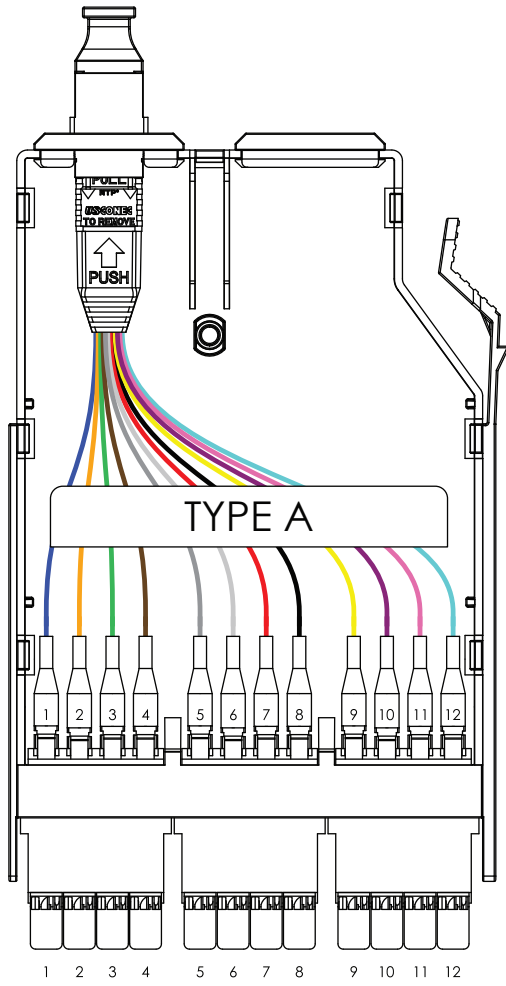

Wiring Design For Duplex Signals (Polarization)

Polarization Type B

