

Patch Cassettes Base-12

Patch Cassette houses the interconnections between fiber optic assemblies and active equipment's. It can accommodate standard MTP, LC and SC connectors and has a fiber capacity of 8/12/24 fiber interconnections per module.

Patch Modules snap easily into position with a fluid and robust sliding mechanism and are compatible with all G-Connect Series high density panels. These cassettes provide a straight through LC, SC or MTP patching field which allows trunk cables to be connected directly to patch cords or harnesses. Designed to facilitate "end-to-end" parallel optics connectivity.

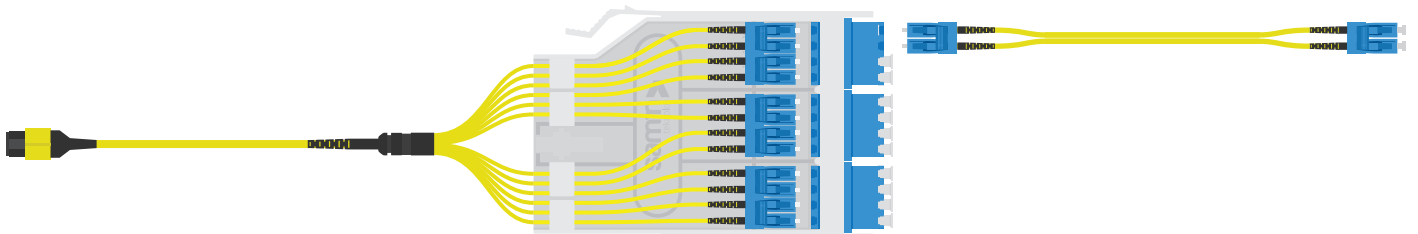
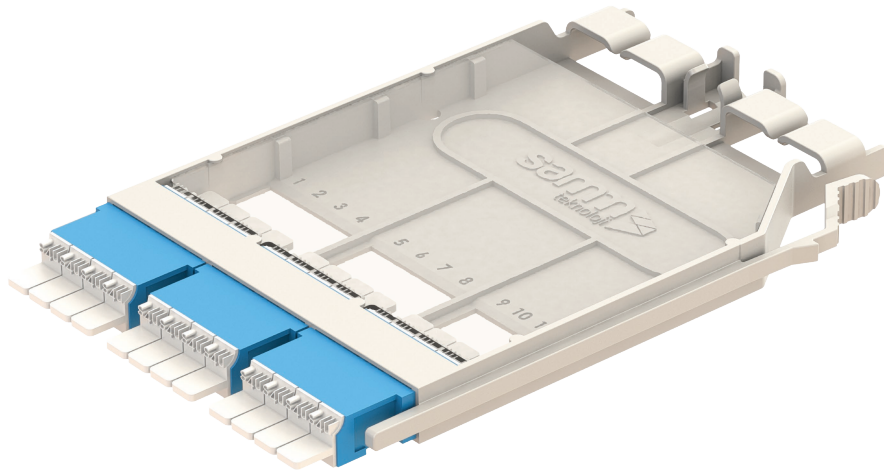

Applications

- Entrance facility
- Data center
- Telecommunications room
- Cellular tower base station
- Consolidation point
- Central office
- Equipment room

Key Features and Benefits

- Front and rear installation options on panel rail guides
- Safety lock design against movement when installed
- Two sides rear cable entry
- Fan-out divider holder
- Engraved Port numbering
- Robust and Strong design

Patch Capacity for 1U G-Connect High Density Panel

Connector Type	LC	SC	MTP-8	MTP-12	MTP-24
Fiber Count	144	144	576	864	1728



Technical Specifications

Cassette Fiber Count Variations	8/12/24/48/72/144 Fibers
Adapters Insertion Loss	≤ 0.1 dB (Typical) ≤ 0.2 dB (Maximum)
Plastic Cassette Materials	PC/ABS Resin, Black
Flammability Rate	UL94-V0
RoHS	Compliant
Operating Temperature	-20°to +60°C
Storage Temperature	-25°to +70°C



Certification And Compliance

ANSI/TIA-942-A Telecommunications Infrastructure Standard for Data Centers	IEC 60874-1 Connectors for Optical Fibers and Cables; Generic Standard
ANSI/TIA-568-C.3 Optical Fiber Cabling Components Standard	IEC 61300 Fiber Optic Interconnecting Devices and Passive Components; Basic Test and Measurement Procedures
TIA-604 series Fiber Optic Connector Intermateability Standard	IEC 60874-1 Connectors for Optical Fibers and Cables ; Generic Standard
TIA-455 series Standard Test Procedure for Fiber Optic Components	UL 94 Tests for Flammability of Plastic Material for Parts in Devices and Appliances
GR-326-CORE Generic Requirements for Single Mode Optical Connectors and Jumper Assemblies	RoHS Directive on Restriction of Hazardous Substances

LC Patch Modules

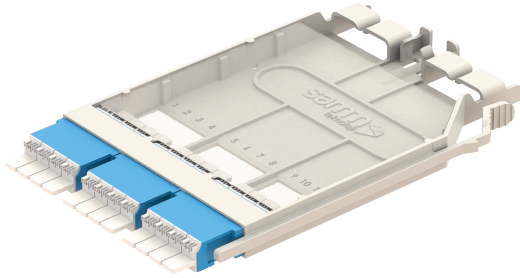

UHDM-PATCH-3xLCQDBLU-OS2

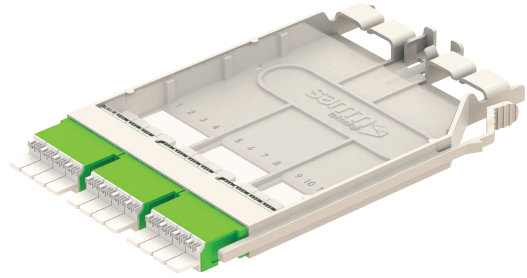

UHDM-PATCH-3xLCQDGRN-OS2

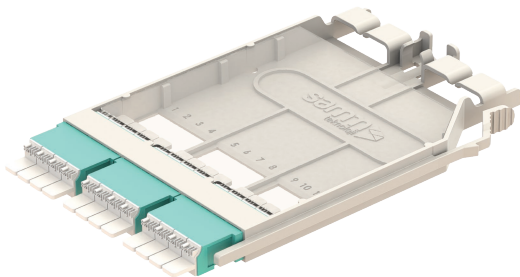

UHDM-PATCH-3xLCQDAQU-OM3

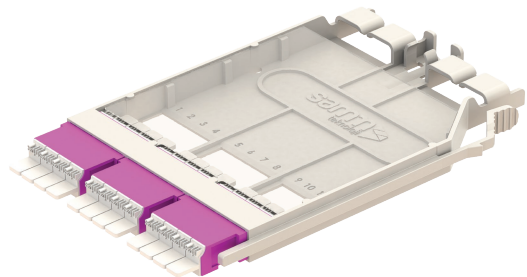

UHDM-PATCH-3xLCQDVIO-OM4

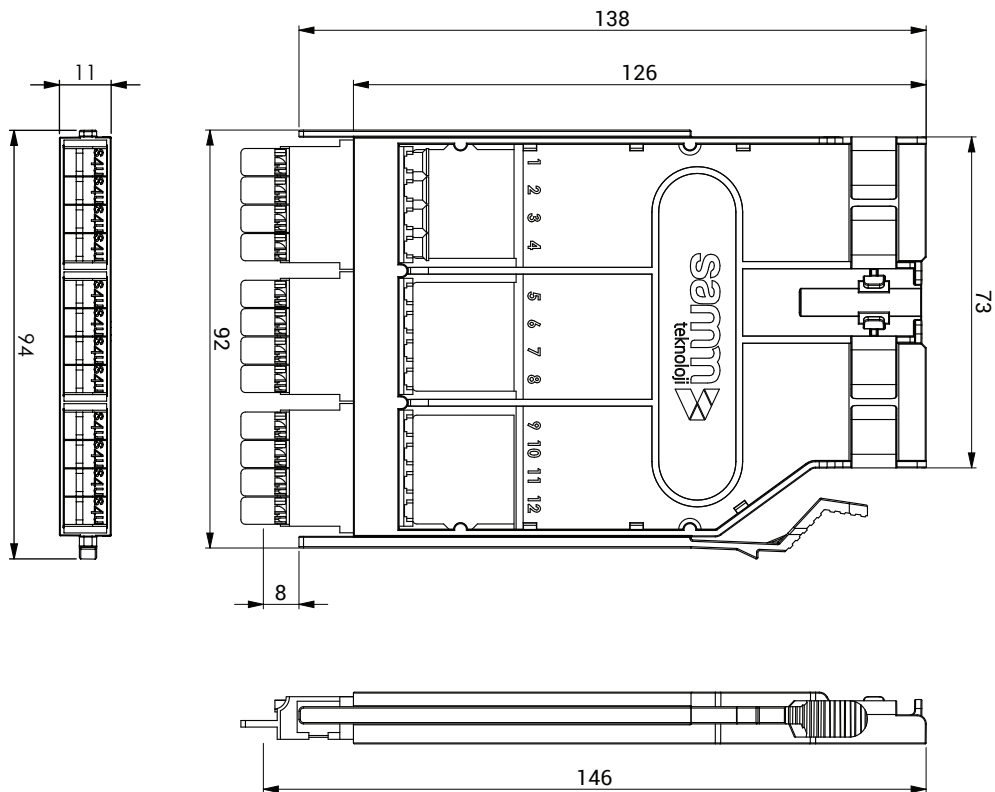

SC Patch Modules

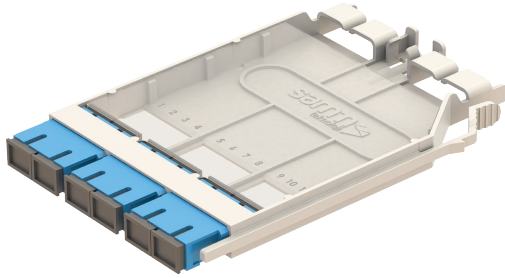

UHDM-PATCH-3xSCDXBLU-OS2

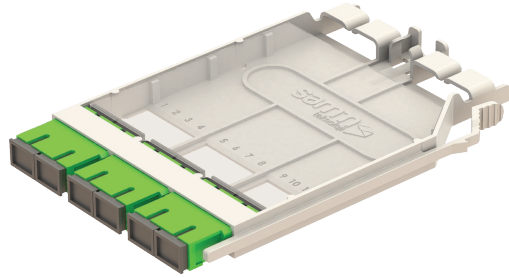

UHDM-PATCH-3xSCDXGRN-OS2

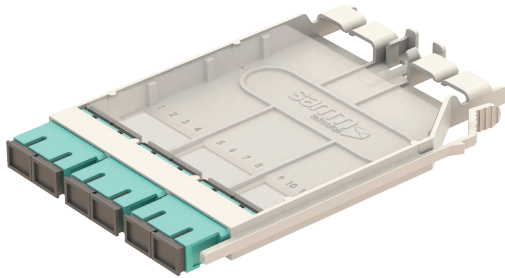

UHDM-PATCH-3xSCDXAQU-OM3

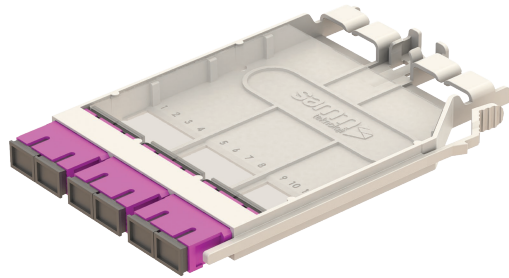

UHDM-PATCH-3xSCDXVIO-OM4

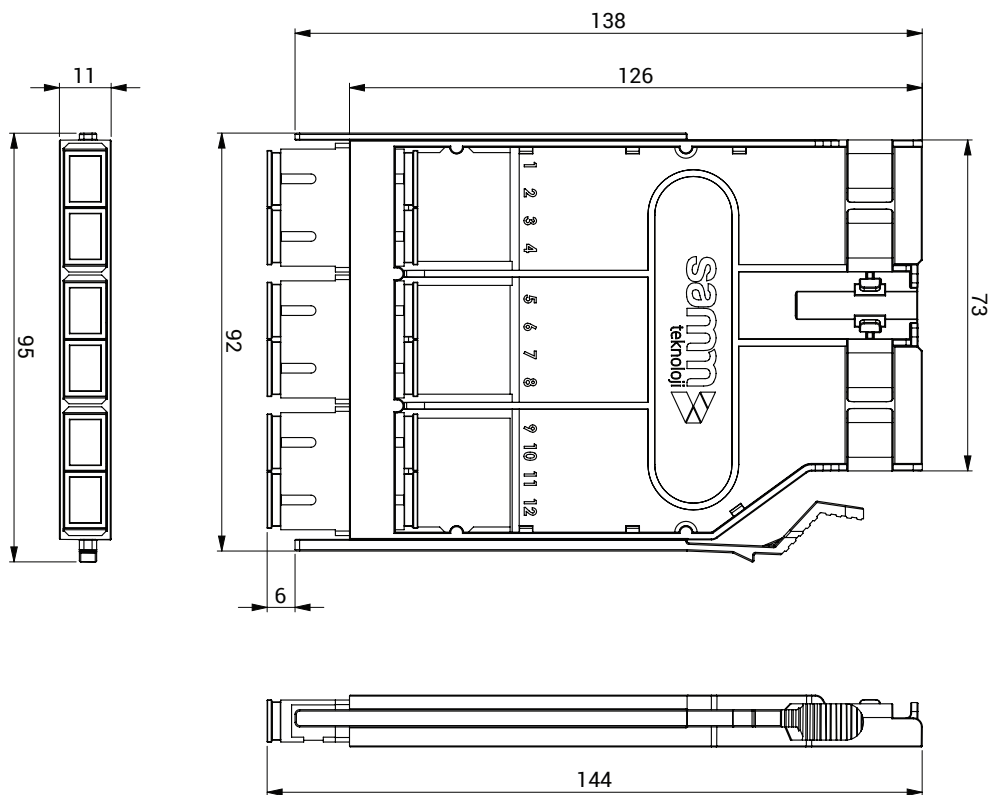

MTP Patch Modules

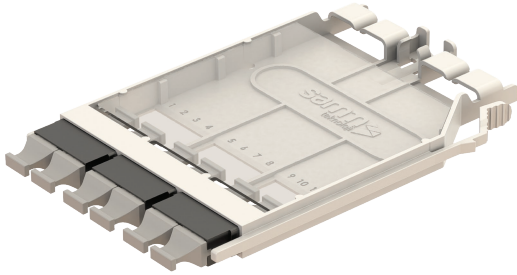

UHDM-PATCH-3xMTPDXBLK(OPPOSED)

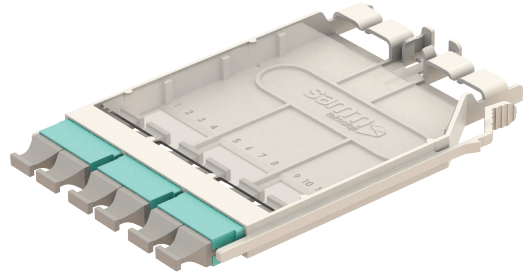

UHDM-PATCH-3xMTPDXAQU(OPPOSED)

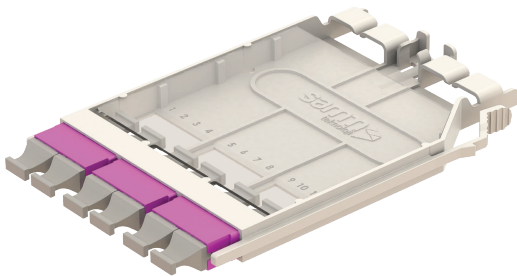

UHDM-PATCH-3xMTPDXVIO(OPPOSED)

