

2U High Density Modular Fiber Panels

2U high density modular fiber optic panels can terminate, organize and distribute up to 96 fibers. This panel is designed to be mounted on 19" rack systems and it has 8 slots in a 2U unit that can hold MTP/LC conversion cassettes and MTP/LC/SC patch adapter modules. This HD Modular fiber optic panel is compatible with optional accessories such as pre-installed inner splicing trays, cable tie-up plates, fanout fixing plates, blind plates, optical adapters and fiber pigtailed. High Density Modular Fiber Panels are generally used in data centers.

Optional Modularity for Different Applications

2U Empty Panel



2U MTP to LC Conversion Panel

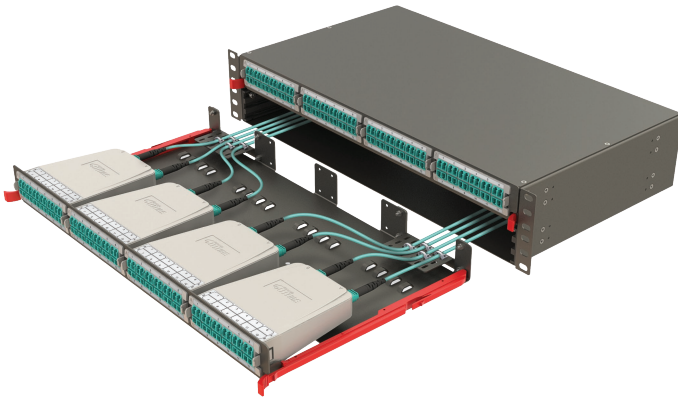

2U Patch to Patch Panel

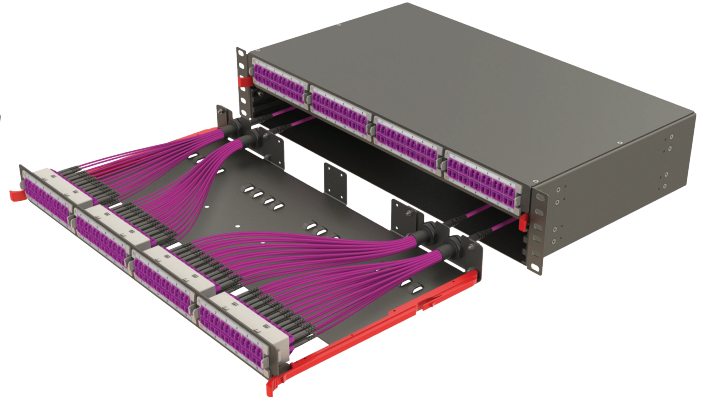





Panel Capacity

Type of Modules		Conversion Modules		Patch Modules	
		MTP to LC	MTP to MTP	LC	SC
2U Panel (8 Slots)	Module Capacity	12/24	96/144/288	24	12
	Panel Capacity	96/192	768/1152/2304	192	96

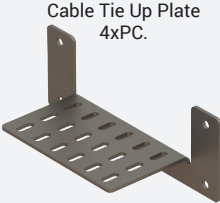
Ordering Codes

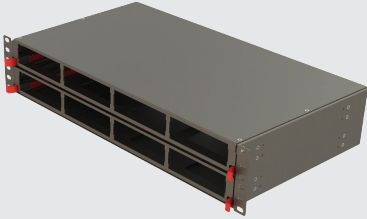
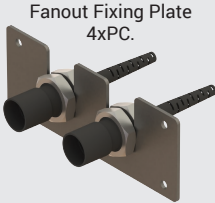
Standard Content

Product Illustration		Code and Description
	<p>Cable Tie Up Plate 4xPC.</p>  <p>Blind Plate for Rear Closing 2xPC.</p> 	<p>HDM-PANEL-2U-8SL-V0-X1-BLK-NN 19", 2U, 8 Slots, Empty Modular Panel 4 Cable Tie Up and 2 Blind Plates</p>
	<p>Fanout Fixing Plate 4xPC.</p>  <p>Blind Plate for Rear Closing 2xPC.</p> 	<p>HDM-PANEL-2U-8SL-V0-X2-BLK-NN 19", 2U, 8 Slots, Empty Modular Panel 4 Fanout Fixing and 2 Blind Plates</p>

Optional Ordering Items

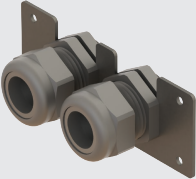
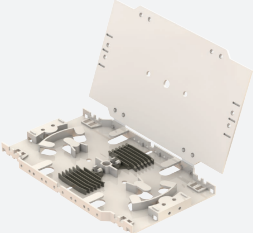
Product Illustration	Code and Description	Product Illustration	Code and Description
	<p>HDM-PANEL-1U_216GP_BLK 2xPG16 Gland Plate-Straight</p>		<p>HDM-PAM-BP-WH Blind Plate for Front Slots</p>
	<p>HD-CASSETTE-24F_WH 24F Fiber Splice Cassette</p>		

Panel Dimensions

Measuring Unit: mm

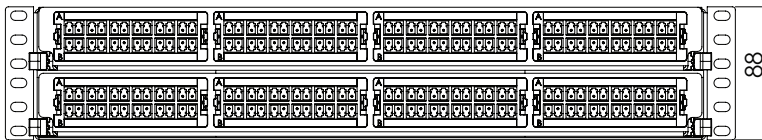
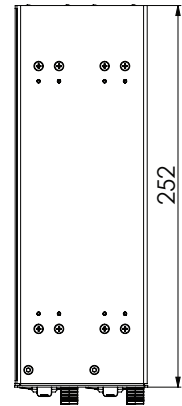
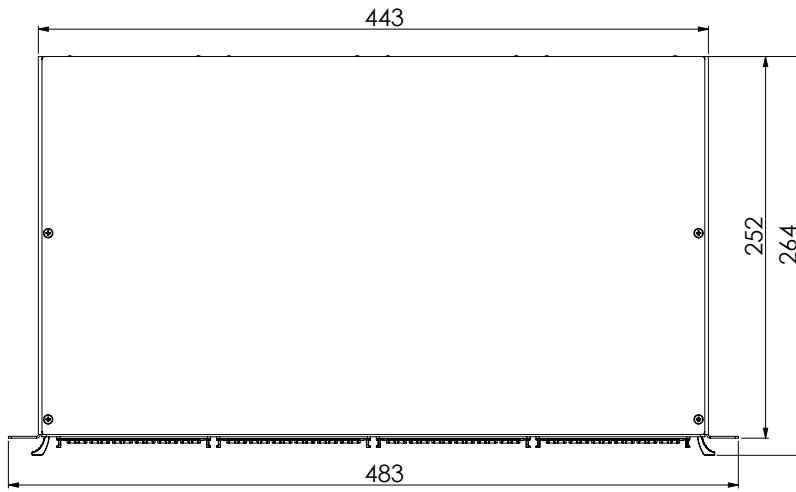

2U